







The long-life battery powered WIFI tracker with tamper alert.

-  Wi-Fi
-  Network triangulation
-  Sigfox
-  Up to 7 years of battery life
-  IP65 & IP67
-  Tamper detection

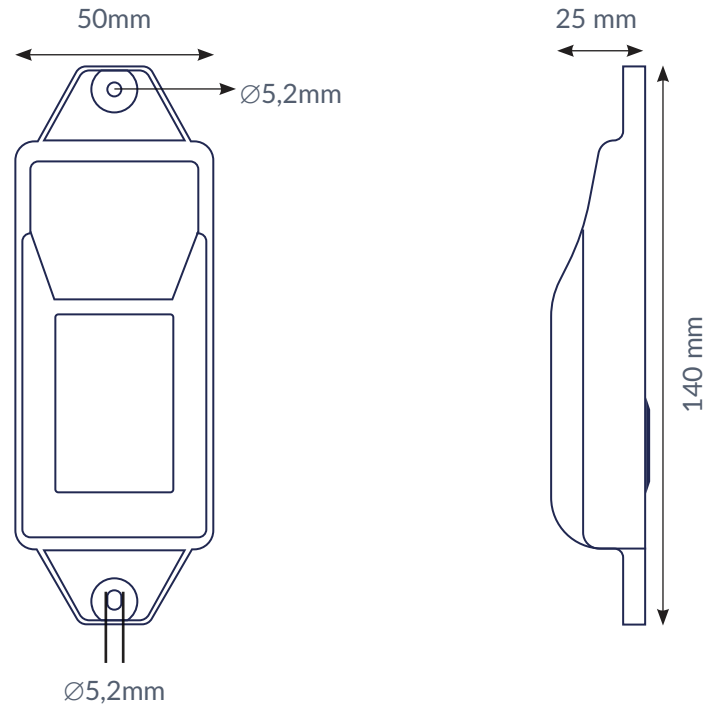

## Connectivity

### Sigfox

- Energy efficient transceiver
- Bi-directional communication
- Regions: RC1

## Geolocalization

### Wi-Fi

Wi-Fi based geolocalization

### Sigfox Atlas

Network based geolocalization

## Sensing

### Internal

- Physical tamper detection
- Relocation based on acceleration

## Mounting

Holes Ø5,2mm for rivets

## Mechanics & design

### Antennas

All antennas are internal

### Size

140 x50x25 mm (L W H)

### Weight

94 gram

### Color

Black

### Water & dust resistance

IP65 and IP67

### Operating temperature

-20°C to 60°C

### Casing

Polycarbonat

---

## Battery

- Up to 5000 messages (~7 years at 2 messages per day)
- Non replaceable battery (Li-SoCl<sub>2</sub>)

---

## Certifications

### Sigfox

RC1

### Regulatory

CE

---

## User interaction

### Device activation

Activation with the tamper button

### LED feedback

No LED feedback on the device

### Synchronize remote settings

Periodic: No user interaction needed

---

## Management services

### Diagnostics

- 4 battery levels
- Communication quality

### Management

- Remote configuration
- Tracker usage profiles

---

## Application services

Localization

Geozones

## Firmware configuration

### Communication service

Data recovery configuration (optional)

### General configuration

- Boot methods
- Time synchronization

### Location service

Periodic and relocation parameters

### Tamper service

Physical tamper button at the back of the device

---

## Security

Sigfox communication AES encryption