







The battery-powered geobeacon for optimization of indoor tracking and zone accuracy of your assets.

-  Bluetooth Low Energy Beacon
-  Omni-directional PCB antenna
-  Max. 100 meters (110 yards) range
-  IP65
-  Ultra-low power nRF52 chipset
-  Battery powered

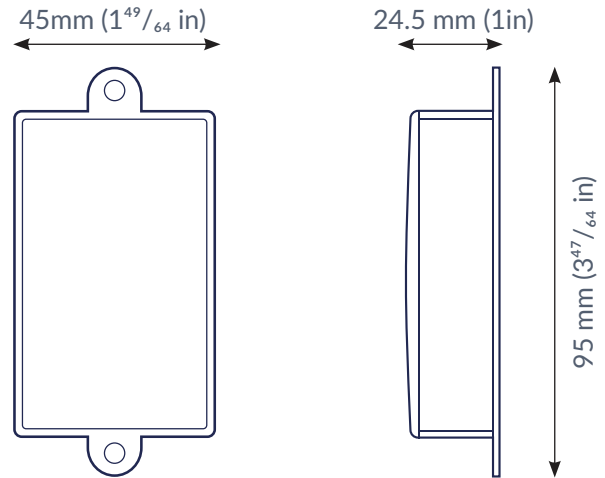

Connectivity

Compatibility

Compatible with all Sensolus trackers with BLE localization

Transmission power

Variabel transmission power up to 100 meter.

Mounting

- Double adhesive mounting tape
- 4 closing screws
- 2 mounting screws
- 2 plastic dowels

Mechanics & design

Antenna

On board PCB antenna

Weight

70 gram (2.5 oz) with 2 batteries

Size

95x 45 x 24.5 mm (3⁴⁷/₆₄ x 1⁴⁹/₆₄ x 1 in)

Casing

Black

Batteries

- 5 years battery life depending on operating mode
- 2 user replaceable AA lithium batteries