







Track 1200 wired is a smart and waterproof GNSS tracker with Bluetooth connectivity and internal backup battery.

-  GPS
-  Built-in accelerometer for accurate crash trace data
-  IP65
-  External power source
-  Internal back up battery
-  Bluetooth for external devices

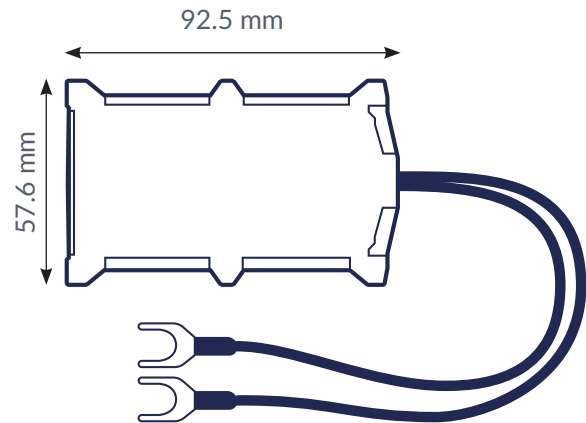

Connectivity

Mobile network

2G (SIM-card is required)

Bluetooth Low Energy (BLE)

Bluetooth Low Energy 4.0

Geolocalization

GNSS

GPS, GLONASS, GALILEO, BEIDOU, SBAS, QZSS, DGPS, AGPS

Mounting

Double sided tape

Mechanics & design

Antenna

- Internal High Gain GNSS antenna
- Internal GSM High Gain Cellular antenna

Size

92.5 x 57.6 x 14 mm (L x W x H)

Weight

63 gram

Color

Black

Sensors

Accelerometer and gyroscope

Water & dust resistance

IP65

Operating temperature

-40 to 85°C (without temperature)

Storage temperature

-40 to 85°C (without temperature)

USB

2.0 Micro-USB

SIM

Micro-SIM

Memory

128MB internal flash memory

Power

- Input voltage: 10 - 30 V DC with overvoltage protection
 - Back up battery : 170 mAh Li-Ion battery 3.7 V (0.63 Wh)
-

Certifications

Regulatory

CE/RED, EAC, REACH, RoHS

User interaction

LED feedback

2 status LED lights

Application services

- Localization
 - Journeys
 - Activity
 - Utilization
 - Speed
 - Travelled distance
 - BLE connectivity
-

Configuration

Configuration and firmware update

- FOTA Web
- FOTA
- Teltonika Configurator (USB, Bluetooth)
- FMBT mobile application (Configuration)

GPRS commands

- Configuration
- Debug

SMS

- Configuration
- Events
- Debug

Time synchronisation

- GPS, NITZ, NTP